

LH END clockwise installation

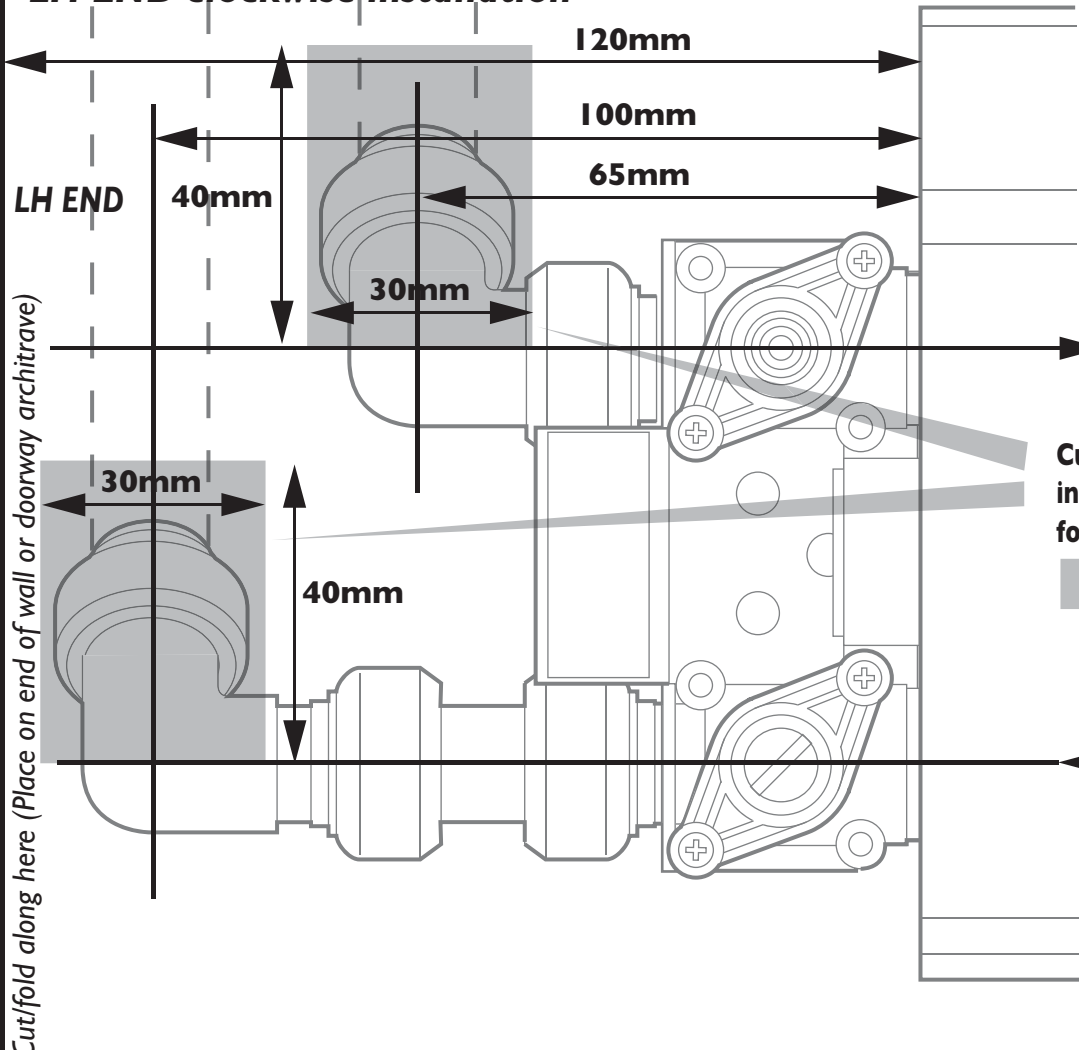

SINGLE TRV INSTALLATION TEMPLATE (SHEET 1 of 2)
(Through cavity wall pipework)

DO NOT SCALE DRG WHEN PRINTING

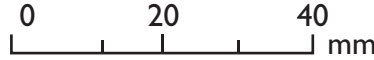

DiscreteHeat
 company limited
 Tel: 0845 1238367 Fax: 01942 892836
 e-mail: info@discreteheat.co.uk
 web: www.discreteheat.co.uk

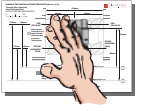

STICK TO WALL TO USE

FEED
 (TRV VALVE)

100mm
 (LT)

130mm
 (OG)

Cut hole through cavity wall in this shaded area to allow for Tectite fittings

RETURN
 (LOCKSHIELD VALVE)

45mm
 (LT)

75mm
 (OG)

Fold along here for **Urban LT** template

WALL

FINISHED FLOOR LEVEL

Fold along here for **Regency OG** template

WALL

FINISHED FLOOR LEVEL

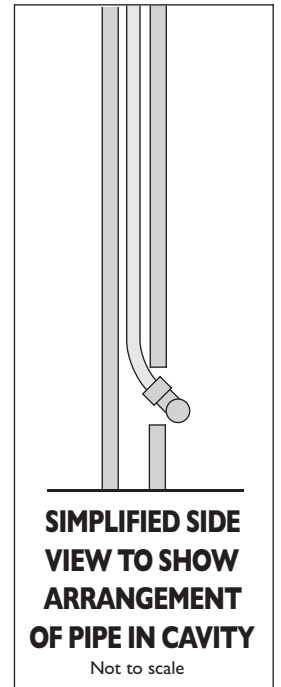

SIMPLIFIED SIDE VIEW TO SHOW ARRANGEMENT OF PIPE IN CAVITY

Not to scale

Cut/fold along here (Place on end of wall or doorway architrave)

RH END anti-clockwise installation

SINGLE TRV INSTALLATION TEMPLATE (SHEET 2 of 2)

(Through cavity wall pipework)

DiscreteHeat
 company limited
 Tel: 0845 1238367 Fax: 01942 892836
 e-mail: info@discreteheat.co.uk
 web: www.discreteheat.co.uk

DO NOT SCALE DRG WHEN PRINTING

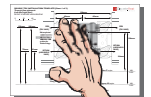
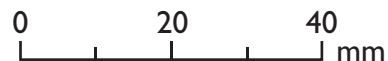

STICK TO WALL TO USE

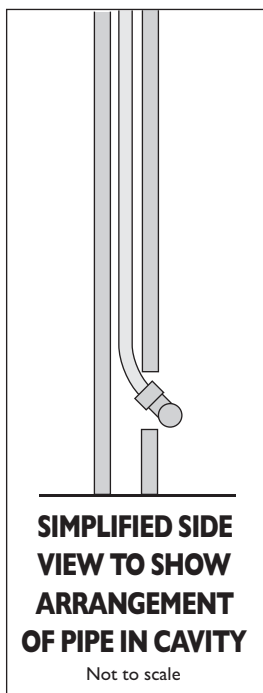

130mm (OG)

100mm (LT)

75mm (OG)

45mm (LT)

FEED (TRV VALVE)

Cut hole through cavity wall in this shaded area to allow for Tectite fittings

RETURN (LOCKSHIELD VALVE)

WALL

Fold along here for **Urban LT** template

FINISHED FLOOR LEVEL

WALL

Fold along here for **Regency OG** template

FINISHED FLOOR LEVEL

Plan view for drilling feed and return pipe holes in floor

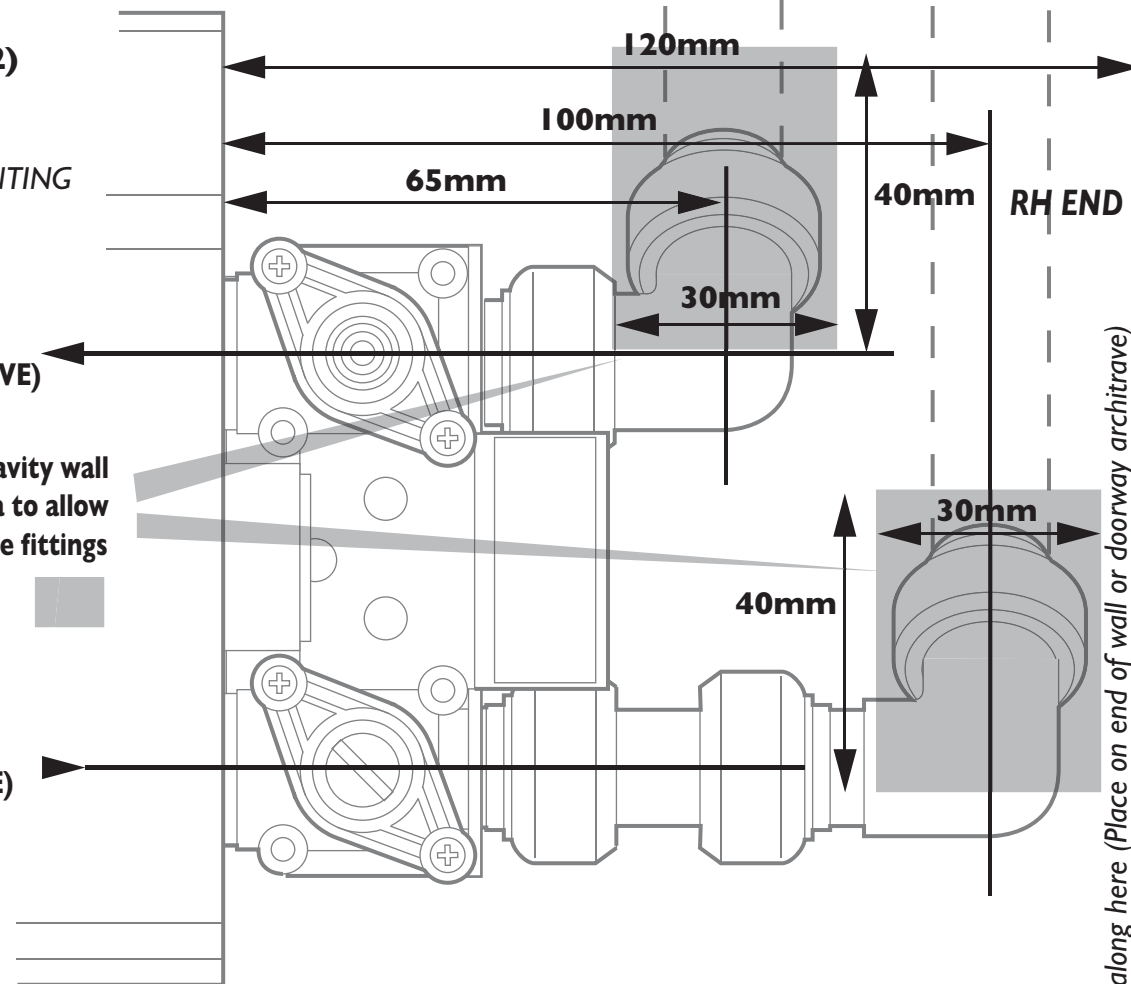

Cut/fold along here (Place on end of wall or doorway architrave)